

ClimaSense Solar Attic & Garage Fan Installation Instructions

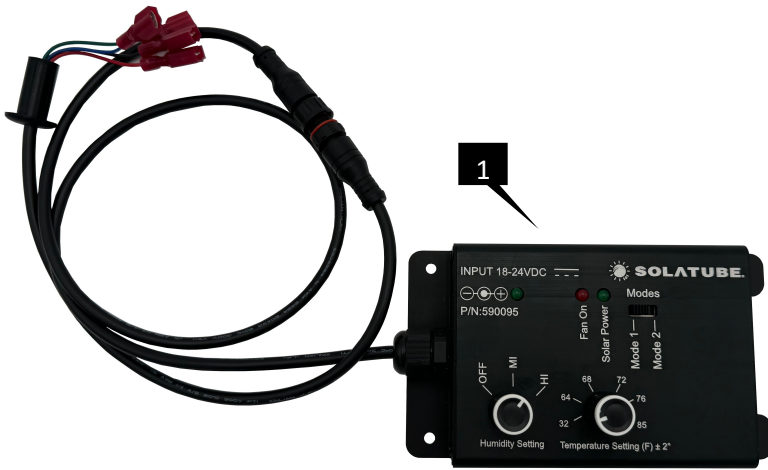

Parts List *		Quantity
1	ClimaSense Solar Controller w/Sub Wire Harness	(1)
2	AC/DC Power Supply w/6 ft. Cable	(1)
3	4 X 10mm Truss Head Screw	(4)
4	Zip Tie	(3)
5	ClimaSense Extension Cable 30 ft. (Sold Separately)	(1)

Required Tools:

Saber or Reciprocating Saw

Drill Bit 1/2 in.

Pliers

Hammer

Flat Bar

Utility Knife

Tape Measure

Caulking Gun

Screw Gun with Phillips Head

Lumber Crayon

Cutting Dykes / Diagonal Cutter

Required Safety Equipment

*High Velocity Hurricane Zones: To meet requirements, Solar Star HVHZ RM 1500 (part# 122290) and HVHZ RM 2400 (part# 122440) must be installed with 6 in High flashing.

HVHZ models are approved for tile roof and asphalt shingle applications.

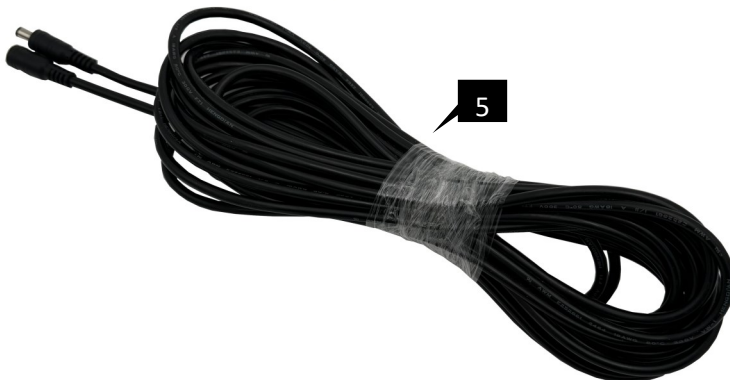

WARNING



Do not proceed with the installation until you have read the entire instructions, including these warnings. (Use of materials or methods not authorized by Solatube International will result in an invalid warranty.)

Solatube International, Inc. (seller) assumes no responsibility or obligation whatsoever for the failure of an architect, contractor, installer, or building owner to comply with all applicable laws, ordinances, building codes, electrical codes, energy codes, fire and safety codes and requirements, roof warranties and adequate safety precautions. Installation of this product should be attempted only by individuals skilled in the use of the tools and equipment necessary for installation. Protect yourself and all persons and property during installation. If you have any doubt concerning your competence or expertise, consult a qualified expert before proceeding.



Install at your own risk!

Solatube product installations may be dangerous and include the potential for death, personal injury and property damage. The hazardous conditions include but are not limited to the following:

- Solatube Daylighting System and Solar Star products may have sharp edges. Always wear leather or canvas gloves while handling and installing products.
- Solatube product installations require climbing and working at dangerous heights, including on ladders, scaffolding, roofs and in attic spaces. Risk of death, personal injury and property damage may result from a fall, or from falling objects. Use extreme caution to minimize risk of accidental injury, including, but not limited to the following procedures:
 - Clear area below your work space of all people, animals and other items.
 - Avoid working on surfaces that are slippery or wet.
 - Use foot-wear with excellent traction.
 - Use only strong, well supported ladders.
 - Work only in calm dry weather.
 - When in the attic, ensure that your weight is supported at all times with structurally sound framing; drywall material is not designed to carry a person's weight.
- To reduce the risk of fire, electric shock, and personal injury, basic safety precautions should always be followed when using electric tools, including always wearing safety goggles or other suitable eye protection, and ensuring work area is clear of all electrical wires, gas pipes, water pipes, and other obstacles.
- When working in the attic or other dusty areas, use of a mask or respirator is recommended to avoid lung irritation. Attic spaces may be dark, confined, and subject to extreme temperatures. Beware of sharp protruding objects. Do not attempt installation without having someone within range of your voice or close enough to come to your aid if necessary.
- Solatube products are not designed to withstand the weight of a person, tools or other objects. Walking or placing objects on the system could cause personal injury and property damage. If the product is damaged, the structural capacity may be weakened; therefore the system should be repaired immediately. For safe installation and use, do not deviate from these installation instructions.

Re-Roofing

- Solatube products require special care if removed for re-roofing. In order to ensure proper removal and re-installation, please contact your Solatube International representative.



Solar Star Installation Tips

These instructions are a step-by-step guide for the installation of a Solar Star attic ventilation products in the following conditions. For other roof types, please contact your Solatube International representative for additional information.

Built Up Flat Roof - Single Ply/Membrane - Asphalt Shingle - Low/No Pitched - Pitched - Prefabricated Curbs - Metal Roof Panels

- Solar Star products develop 100% of their operational power from the sun; therefore, it is very important that the solar panel be exposed to as much sunlight as possible. The best location for Solar Star products is on the south facing slope.
- Install the Solar Star Roof Mounted Attic Fan just below the top ridge of the roof, since hot moist air will naturally rise to the top portion of the attic. Ensure net free air intake opening is a minimum of 1/150 of attic square footage or is meeting your local building code requirements.
- Keep Solar Star solar panels covered until product is mounted and sealed to roof. Cover solar panel whenever motor, fan, or unit is to be serviced. Fan blade is controlled by the solar panel and may become operational when panel is exposed to sunlight.
- Solar Star products are designed for general ventilation purposes only. Do not exhaust any hazardous materials or gases such as flammable, explosive or incendiary materials.
- Solar Star products have an unguarded fan blade. Do not use Solar Star products in areas that are easily accessible.
- If your home has gable or dormer vents, install the Solar Star Roof Mounted Attic Fan between vents or consider the Solar Star IM1500.

Caution

- Carbon monoxide may be drawn into a house or attic space with the operation of Solar Star products if fuel-burning equipment is not serviced or monitored regularly. Carbon monoxide (CO) is a colorless, odorless gas that can be hazardous to your health and may cause death. Fuel-burning equipment must have proper ventilation, Solar Star products are not designed to provide ventilation for fuel-burning products.

For the most current Installation Instructions, please visit www.solatube.com/instructions

Solatube International, Inc. | 2210 Oak Ridge Way | Vista, CA 92081-8341 | www.solatube.com | T: 888.SOLATUBE

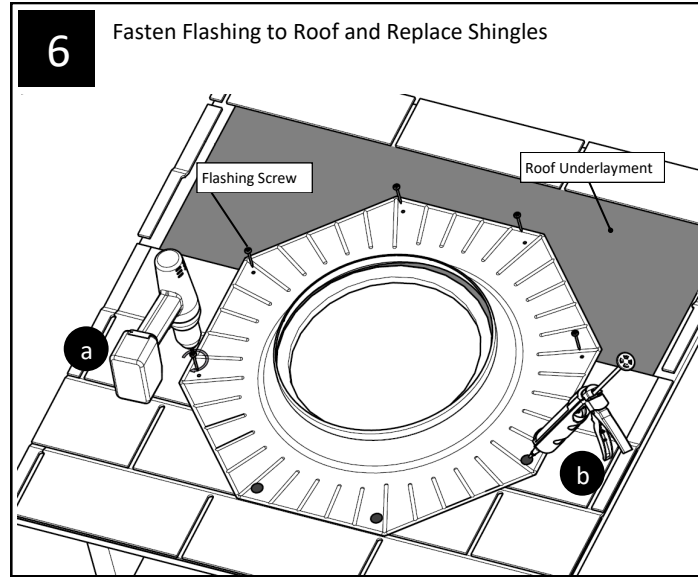
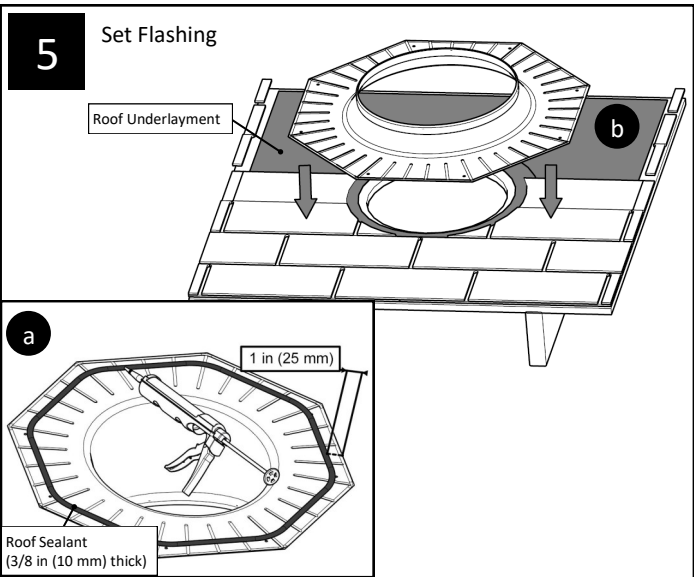
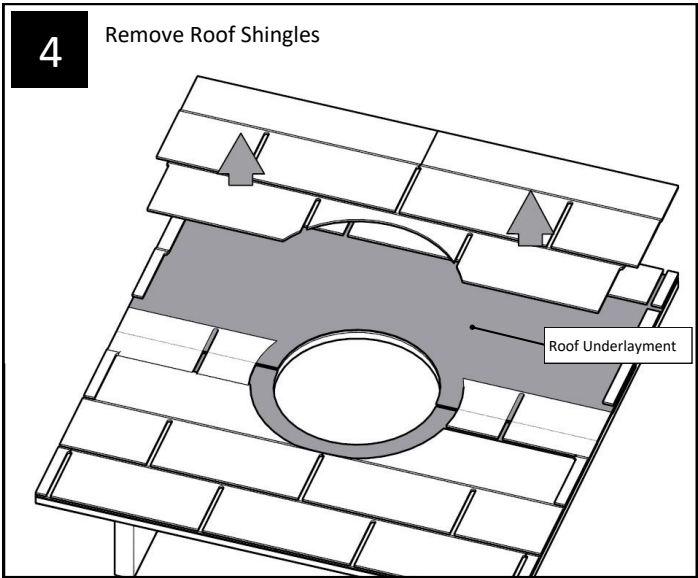
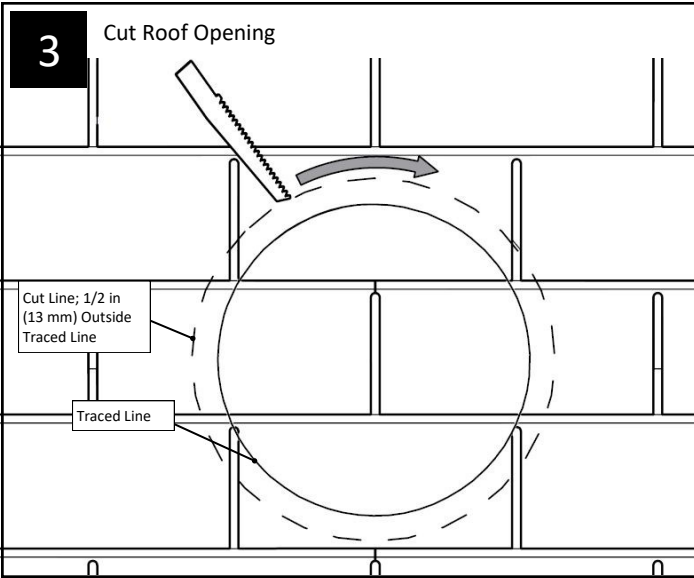
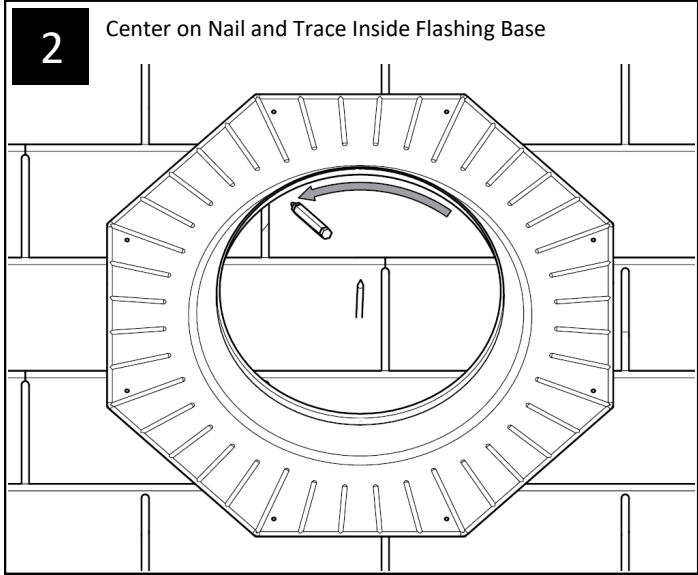
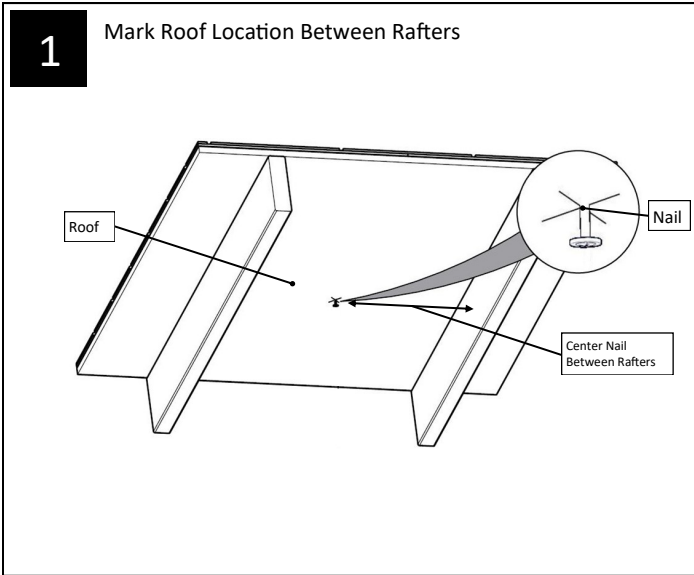

7

Install ClimaSense Controller

Fasten controller, with provided screw fasteners, to framing member inside attic. Allow enough distance to allow the cord to reach through the roof opening and attach to the solar attic fan.



8

Pull cord through roof opening and set aside.



9

Remove Fan Blade Nut

Turn fan blade nut counter clockwise using wrench. Set nut aside and save.



10

Remove Fan Blade

Pull up on fan blade to remove. Set fan blade aside and save.



11

Drill Cable Opening

Drill hole with 1/2 inch drill bit close to standoff.

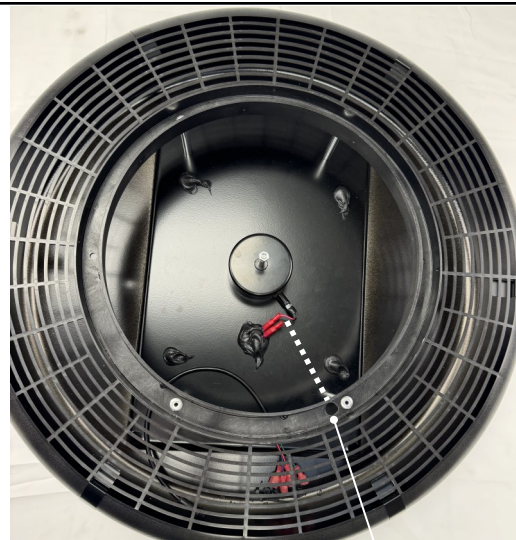
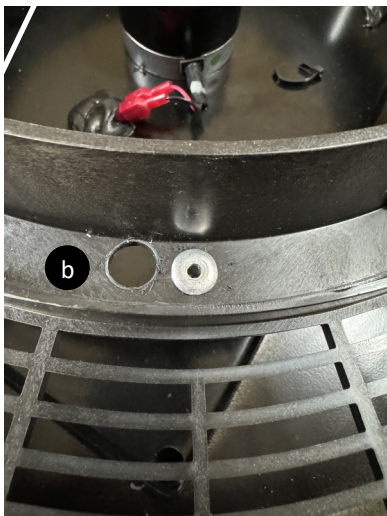
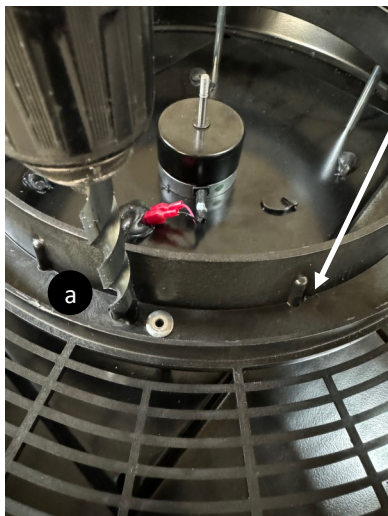

Drill one hole next to standoff that is closest to motor and solar panel wire harness.

12

Insert Cable into Solar Attic Fan

Insert one cable connector at a time through drilled cable opening.

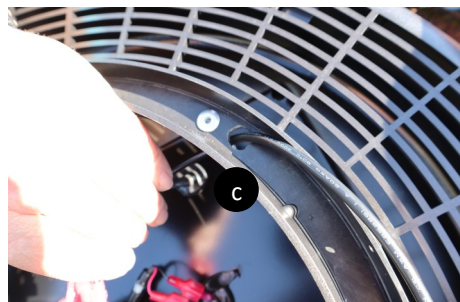
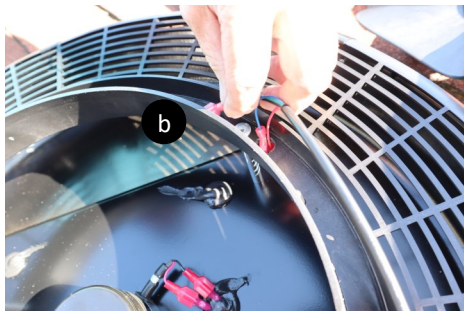
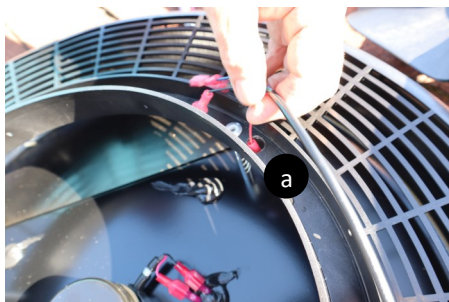

13

Disconnect Motor Cables

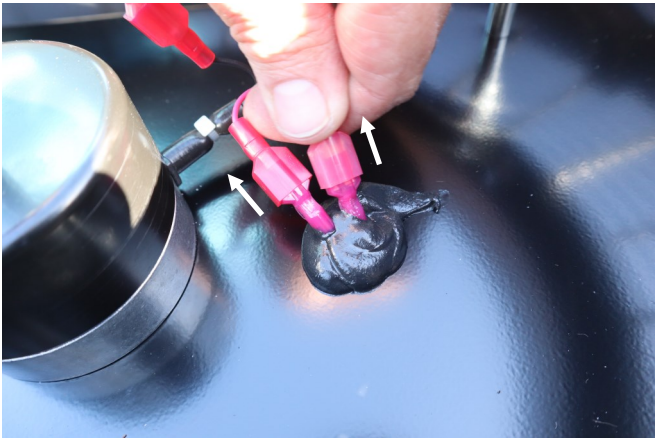

14

Connect ClimaSense Cables to Motor and Panel
 Connect ClimaSense red and green cables to Solar Attic Fan black cable leads. Connect ClimaSense blue and green cables to Solar Attic Fan red cable leads.

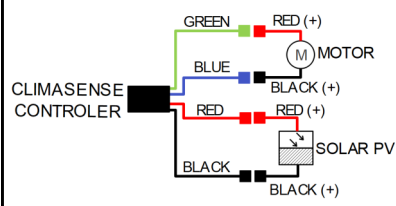

15

Secure Cables

Pull cables tight to prevent from making contact with fan blades. Secure cables to standoff post with provided zip ties.

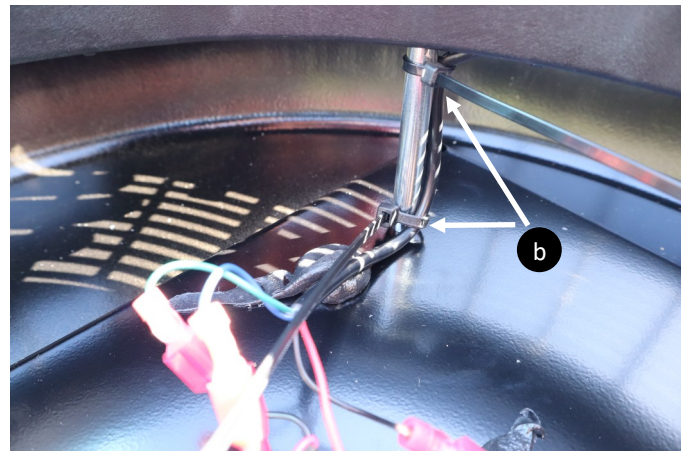
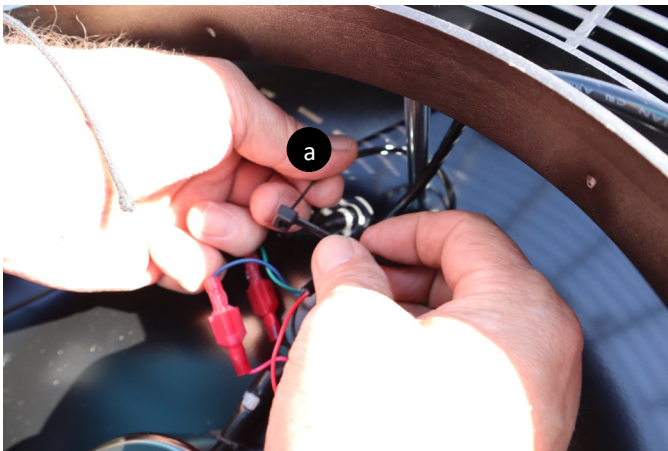

16

Cut Excess Zip Tie

Cut excess zip ties to prevent contact with fan blade.

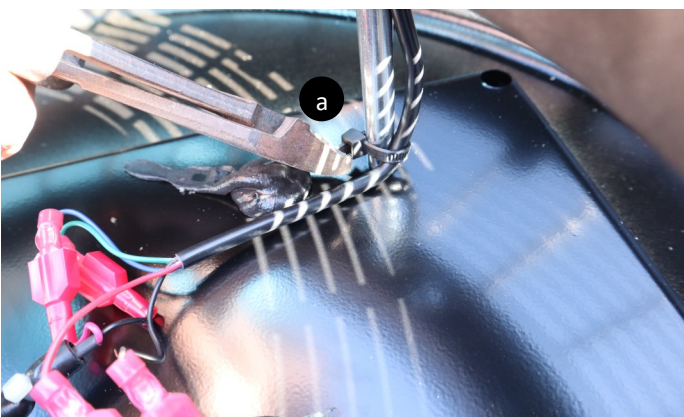

For the most current Installation Instructions, please visit www.solatube.com/instructions

17

Install Fan Blade

Align notch on fan blade with flat portion of motor shaft. Firmly press fan blade onto shaft to seat completely. Install fan blade nut onto motor shaft and secure with wrench turning clockwise.

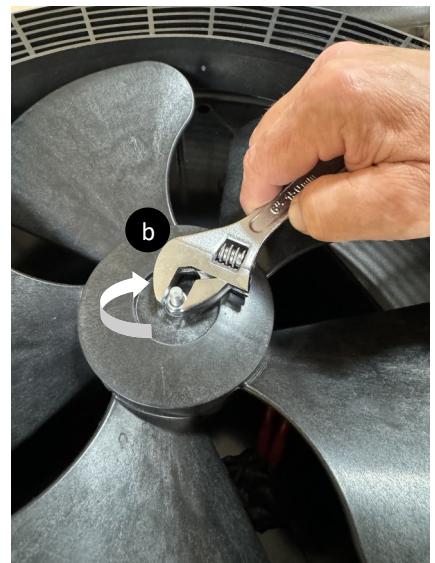

18

Connect Cables

Align cable connection slots. Insert together and tighten.

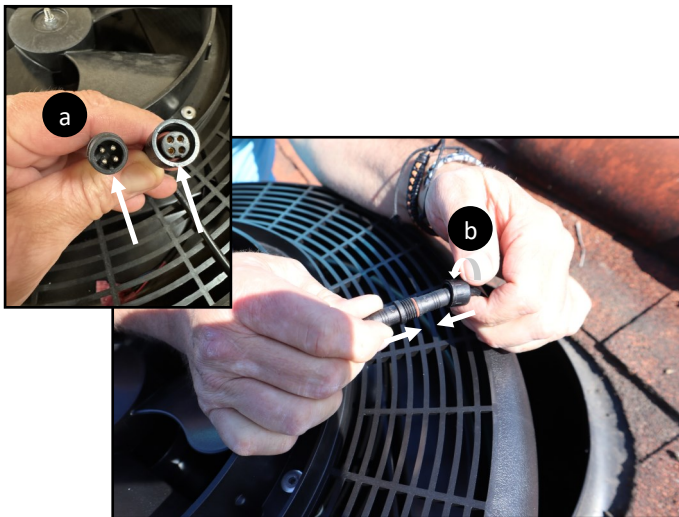

19

Insert Rubber Grommet

Firmly secure rubber grommet into drilled cable opening.

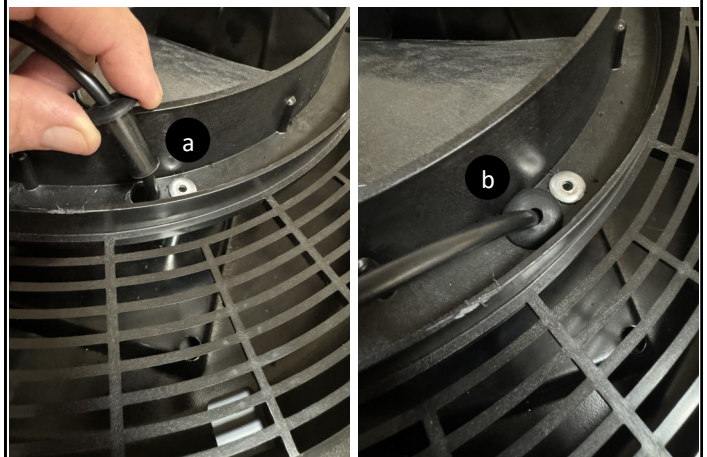

20

Attach Solar Attic Fan to Flashing

Insert cable through roof opening and fasten solar attic fan to flashing. Refer to Solar Attic Fan Installation Instructions Part Number 951900.



21

Plug ClimaSense Power Cord into Outlet
Power cord is provided with a 6 ft. cable.

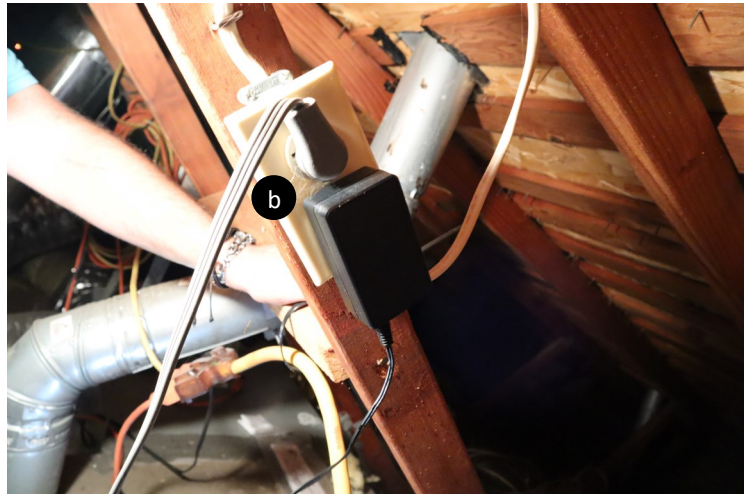

22

Install Extension Cable

If more length is needed, add extension cable to power cord. Can connect up to two (2) extension cables.
Connect one end of extension cable to power cord.
Extension cords are available with a 30 ft. length.

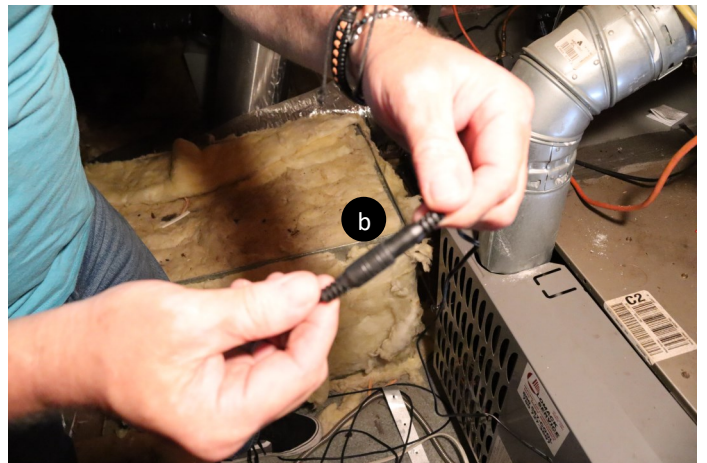
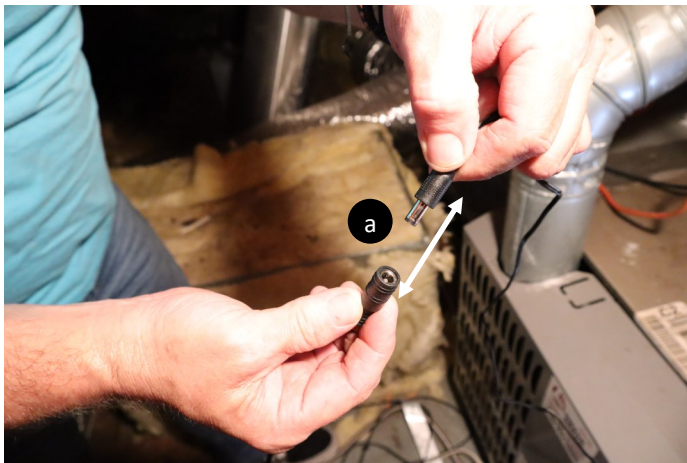

23

Insert Power Cable into ClimaSense Controller
Secure all wires to framing members.
Installation is complete.

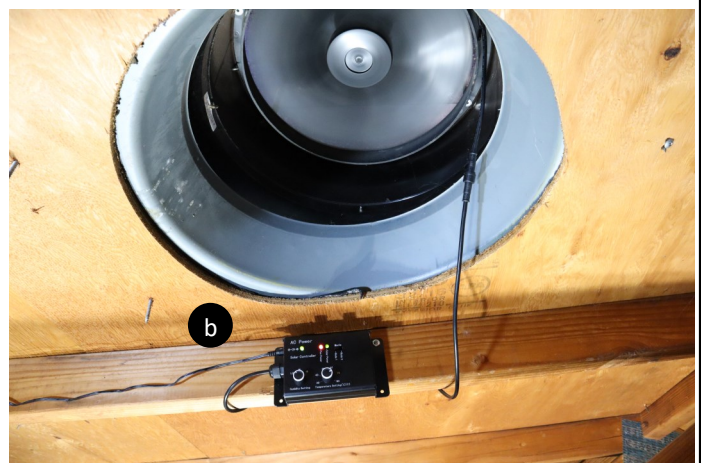

For the most current Installation Instructions, please visit www.solatube.com/instructions

Operating Options

Operational Modes:

Mode 1: Continuous Operation day and night (night time operation 4 hours), ensuring consistent ventilation.

Mode 2: Intelligently responds to humidity and temperature changes.



Mode 2 Settings

Humidity Setting

OFF—Use this setting if only temperature setting is desired.

MI—Low humidity detection. Motor turns on when humidity is greater than medium.

Temperature Setting

Set to desired temperature. Fan will operate when temperature is above set temperature.



Solatube International, Inc.,
2210 Oak Ridge Way, Vista CA 92081-8341
Phone (800) 966-7652 • Fax (760) 599-5181
www.solatube.com Part No. 941586 v1.0